

SITE PLAN  
1:100

JASPER AVENUE

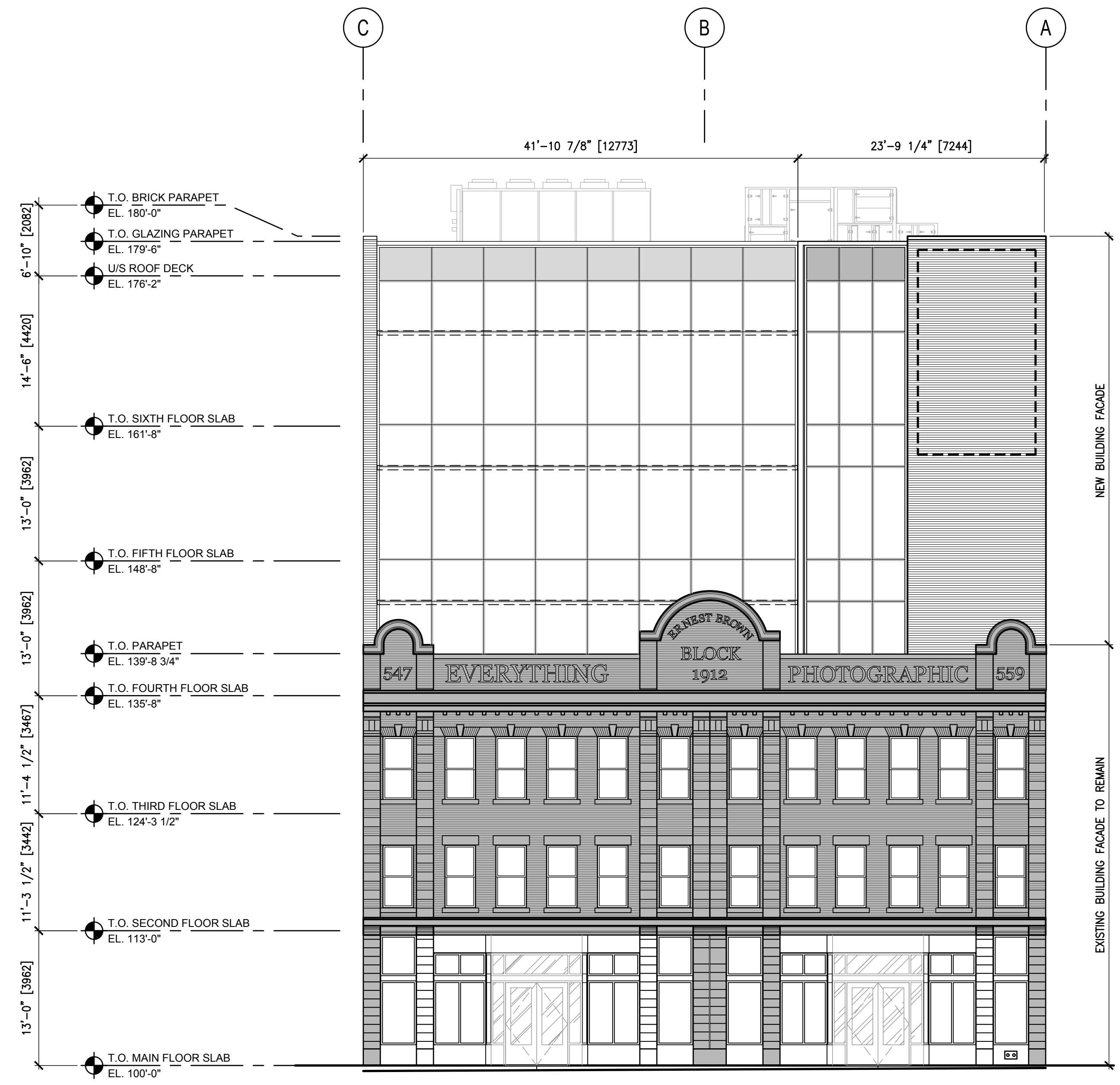

SOUTH ELEVATION  
1/8"=1'-0"

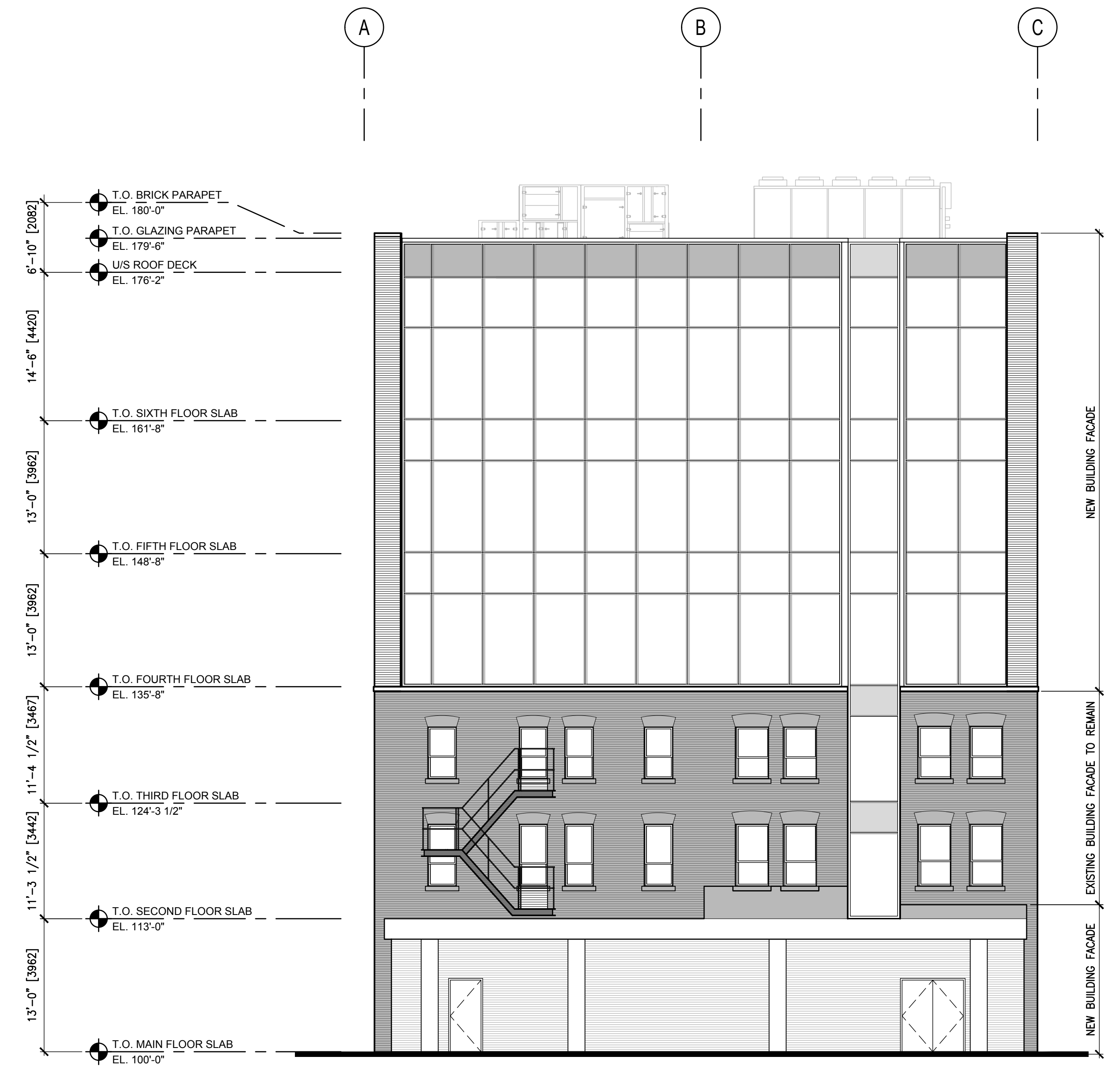

NORTH ELEVATION  
1/8"=1'-0"

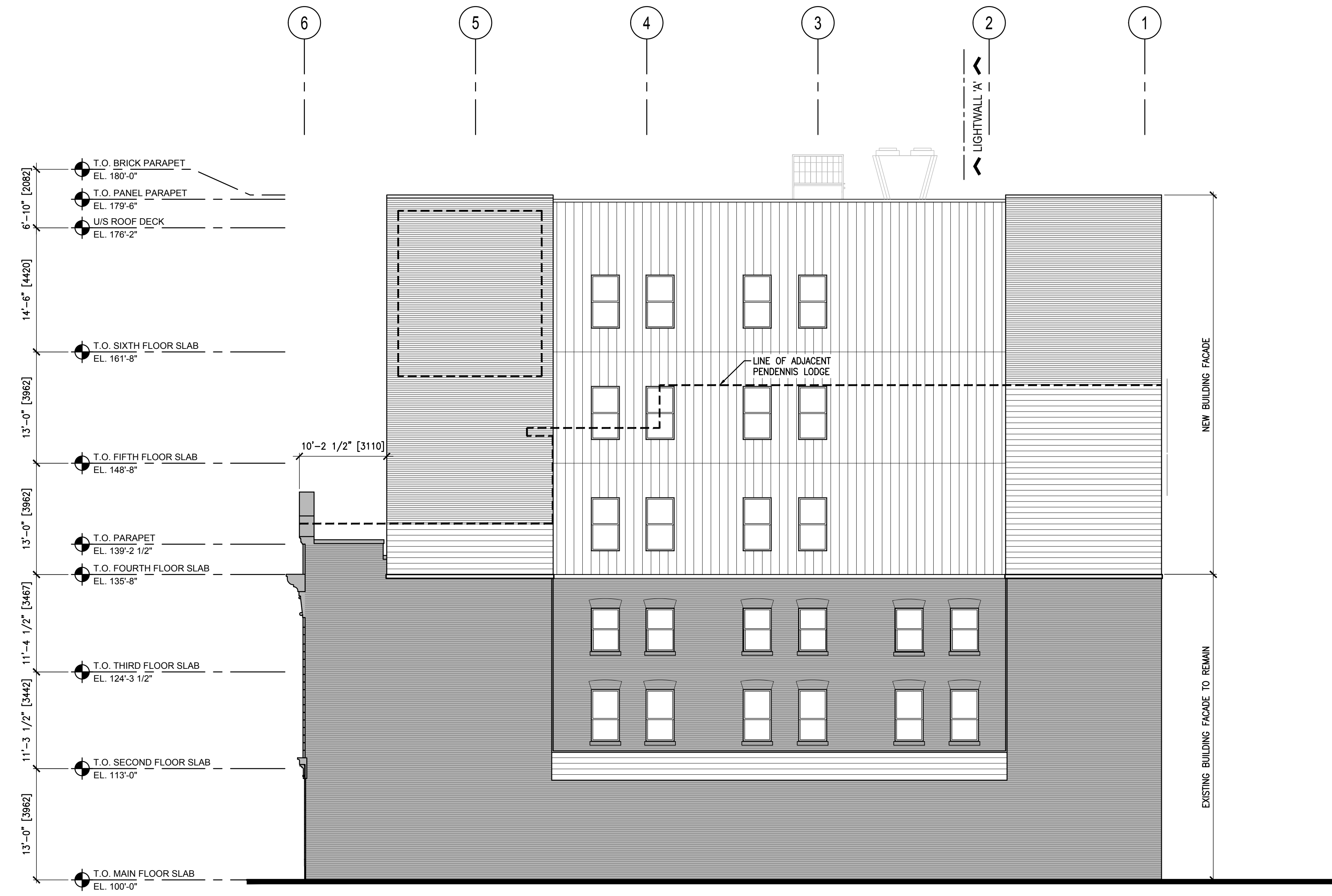

EAST ELEVATION  
1/8"=1'-0"

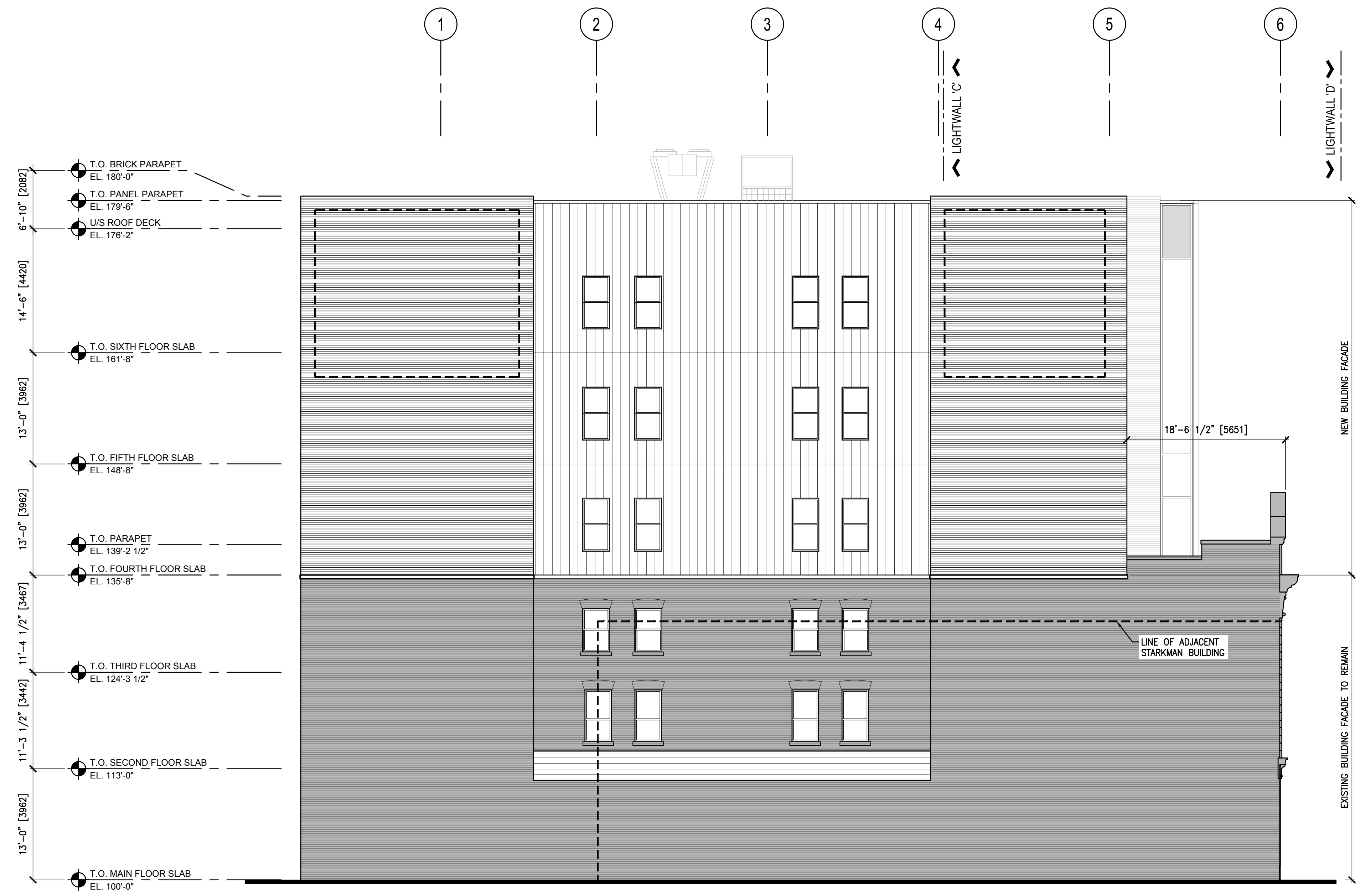

WEST ELEVATION  
1/8"=1'-0"



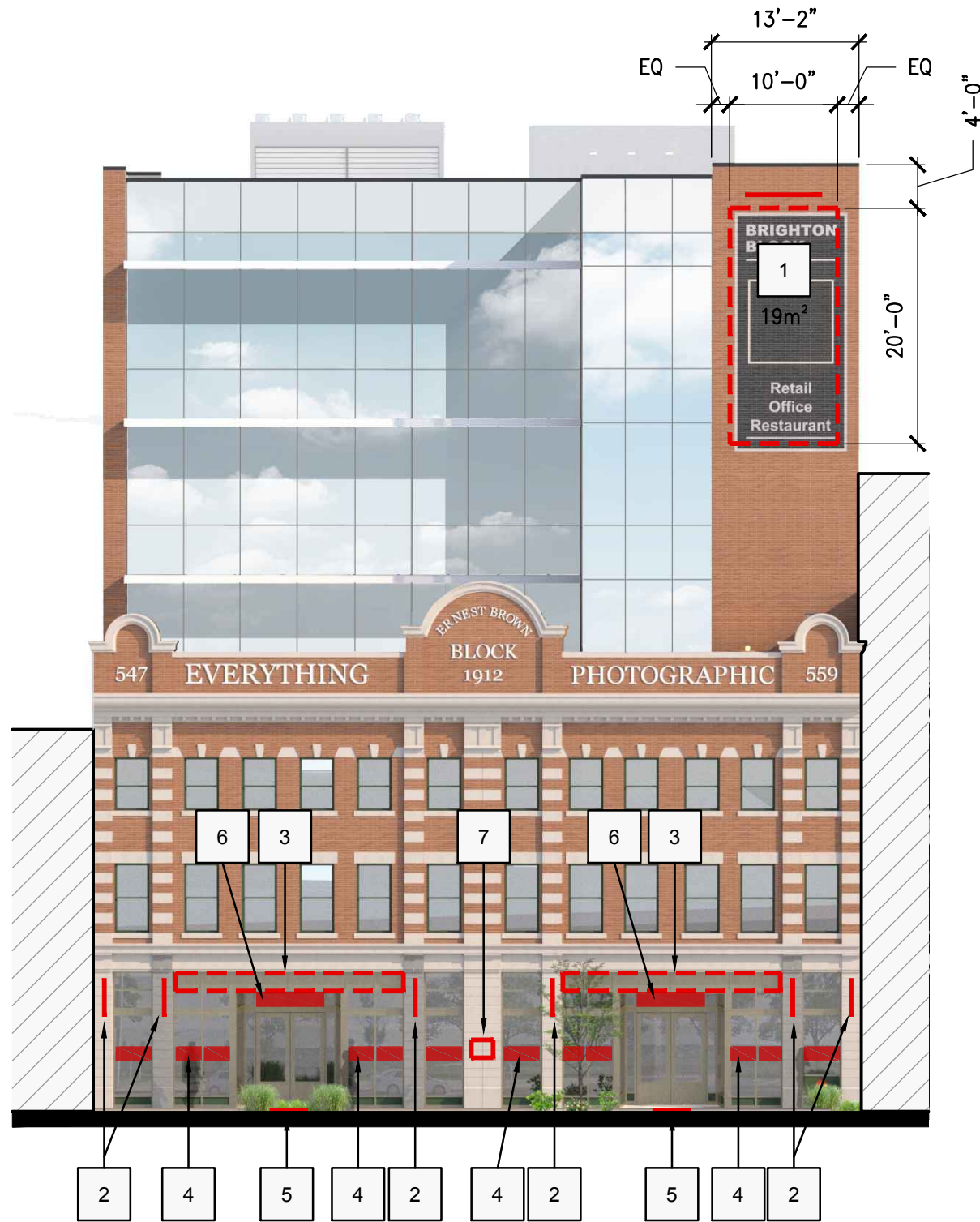

SOUTH ELEVATION

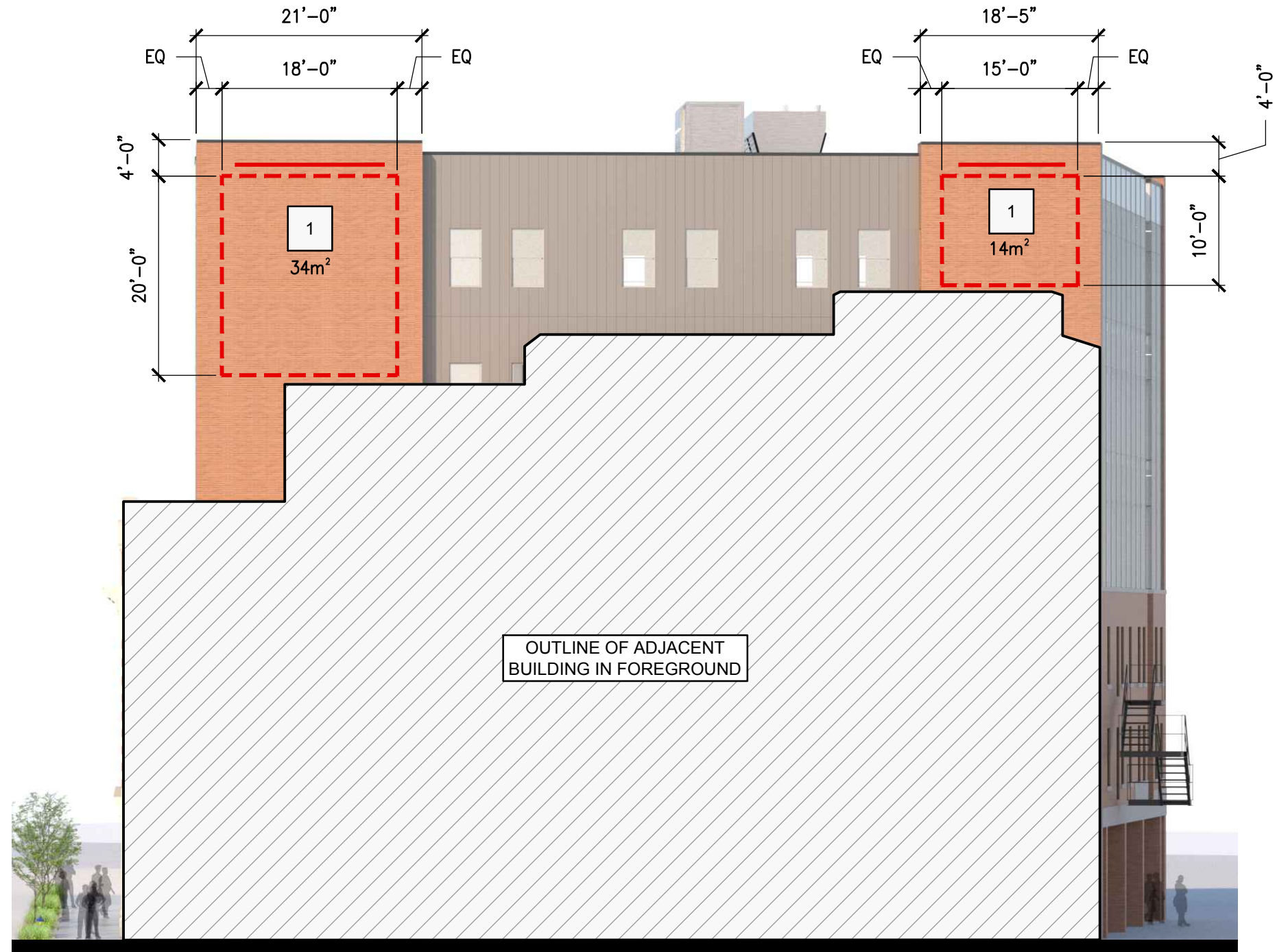

EAST ELEVATION

**SIGNAGE TYPES**

- |   |   |   |   |
|---|---|---|---|
| 1 | GHOST SIGNAGE<br>c/w LED STRIP LIGHTING ABOVE               | 5 | TILE ADDRESS SET INTO<br>ENTRANCE FLOORING      |
| 2 | PROJECTING SIGNAGE  | 6 | TRANSOM WINDOW SIGNAGE                          |
| 3 | RETRACTABLE FABRIC AWNING                                   | 7 | HERITAGE PLAQUE                                 |
| 4 | STOREFRONT WINDOW SIGNAGE<br>APPLIED TO INTERIOR OF GLAZING | 8 | GHOST OR PLAQUE STYLE<br>TENANT PARKING SIGNAGE |

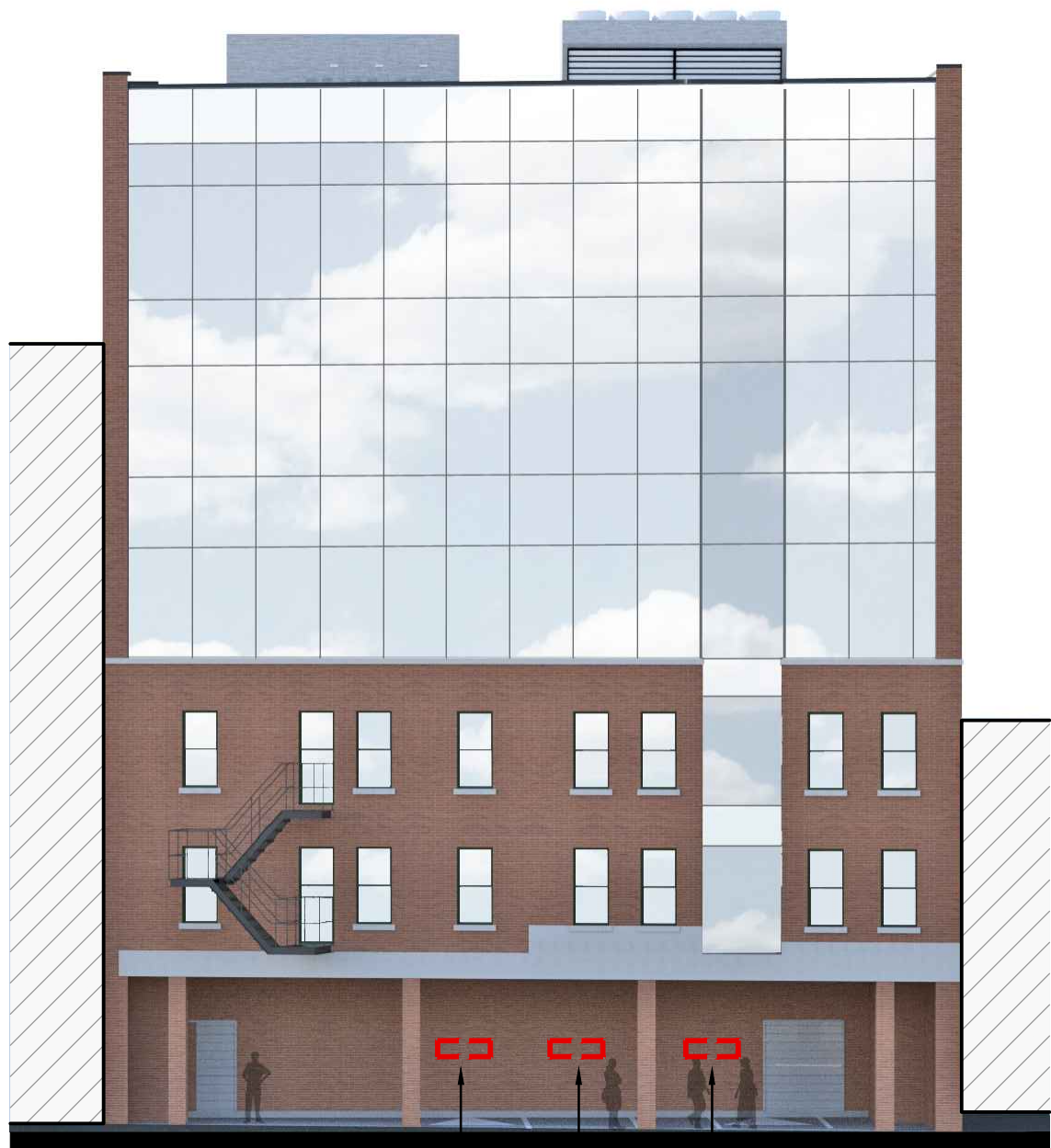

8 8 8

NORTH ELEVATION

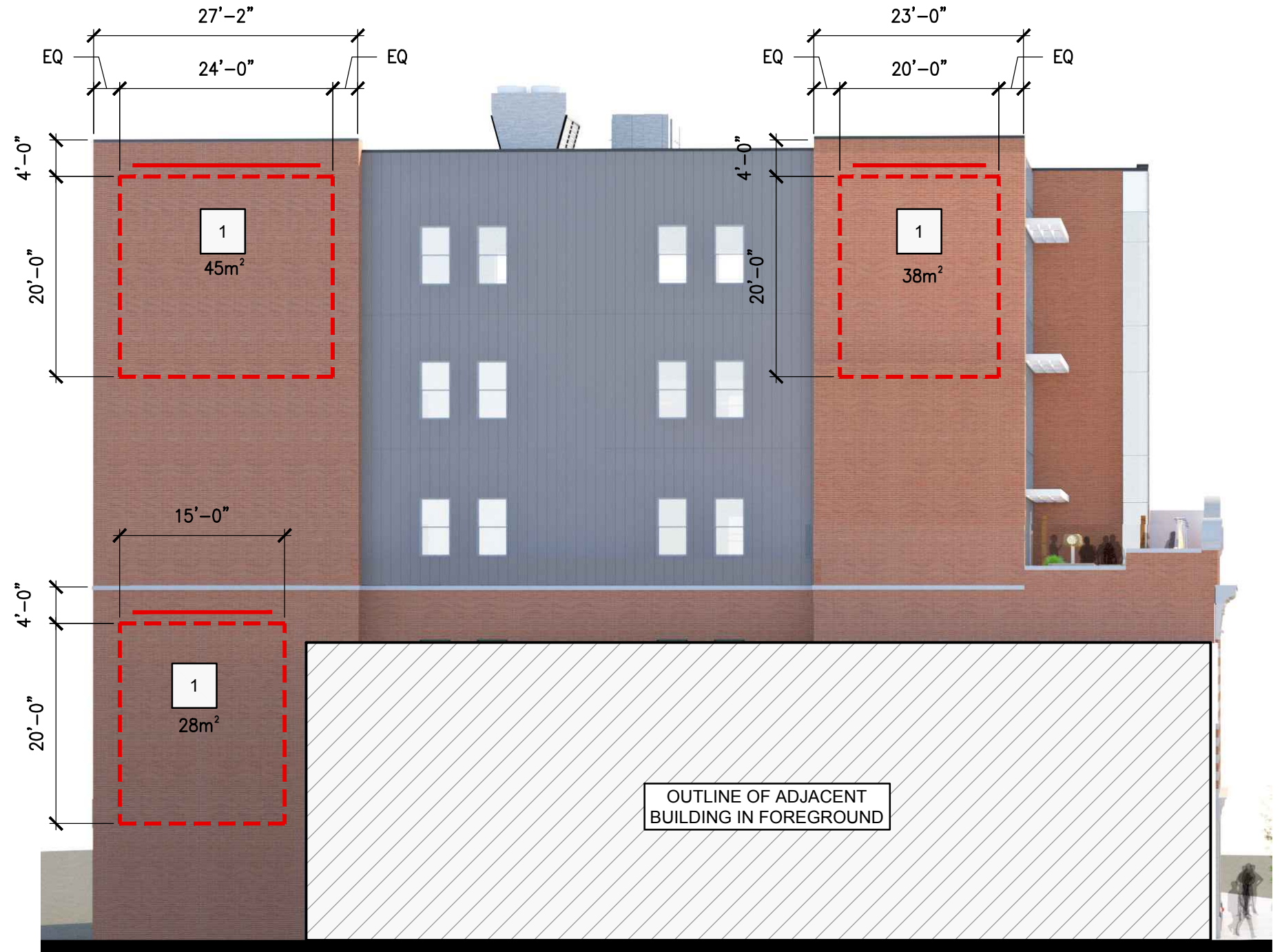

WEST ELEVATION

**SIGNAGE TYPES**

- |   |   |   |   |
|---|---|---|---|
| 1 | GHOST SIGNAGE<br>c/w LED STRIP LIGHTING ABOVE               | 5 | TILE ADDRESS SET INTO<br>ENTRANCE FLOORING      |
| 2 | PROJECTING SIGNAGE  | 6 | TRANSOM WINDOW SIGNAGE                          |
| 3 | RETRACTABLE FABRIC AWNING                                   | 7 | HERITAGE PLAQUE                                 |
| 4 | STOREFRONT WINDOW SIGNAGE<br>APPLIED TO INTERIOR OF GLAZING | 8 | GHOST OR PLAQUE STYLE<br>TENANT PARKING SIGNAGE |

# RETRACTABLE AWNINGS

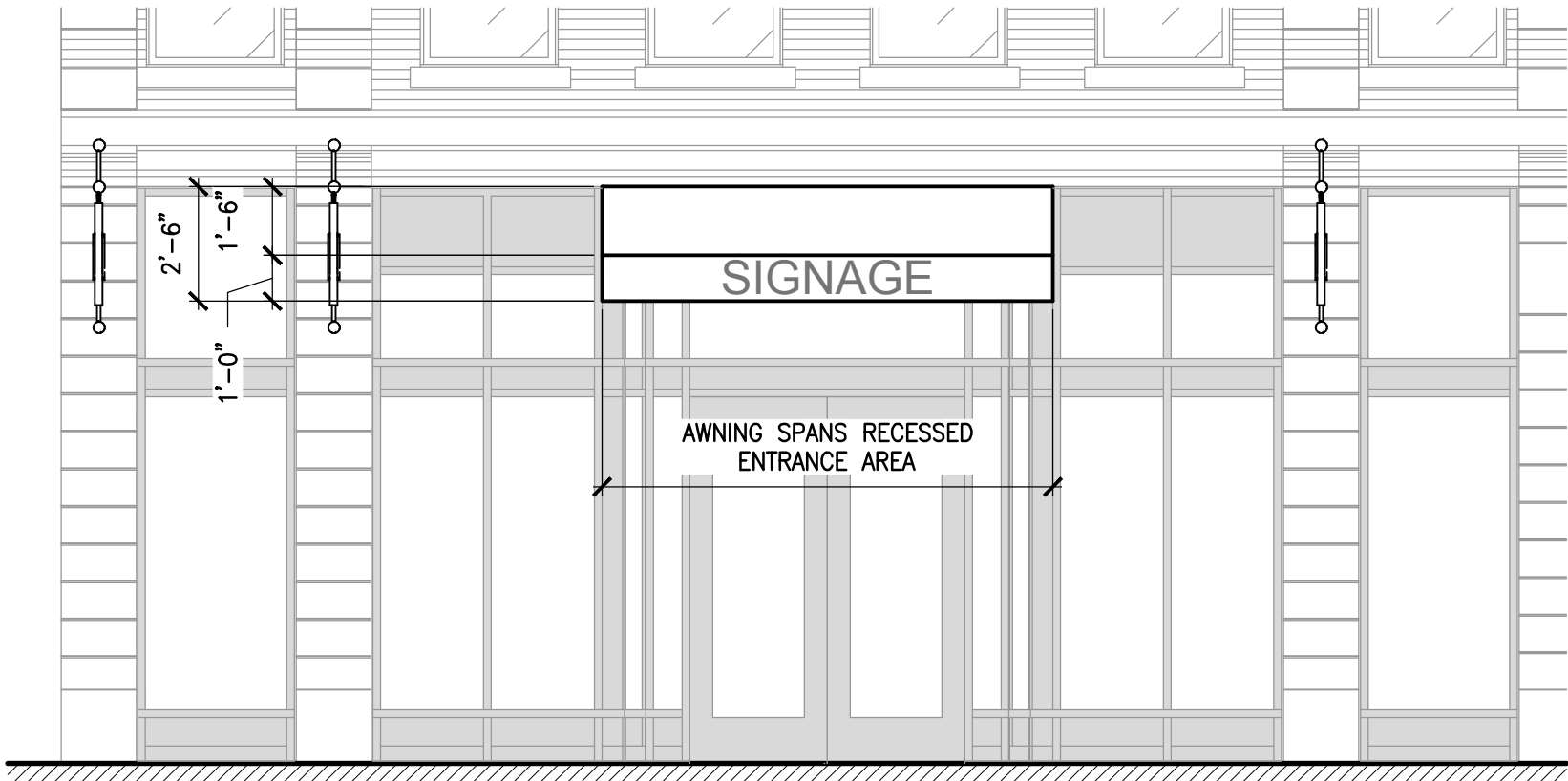

ELEVATION - OPTION 1

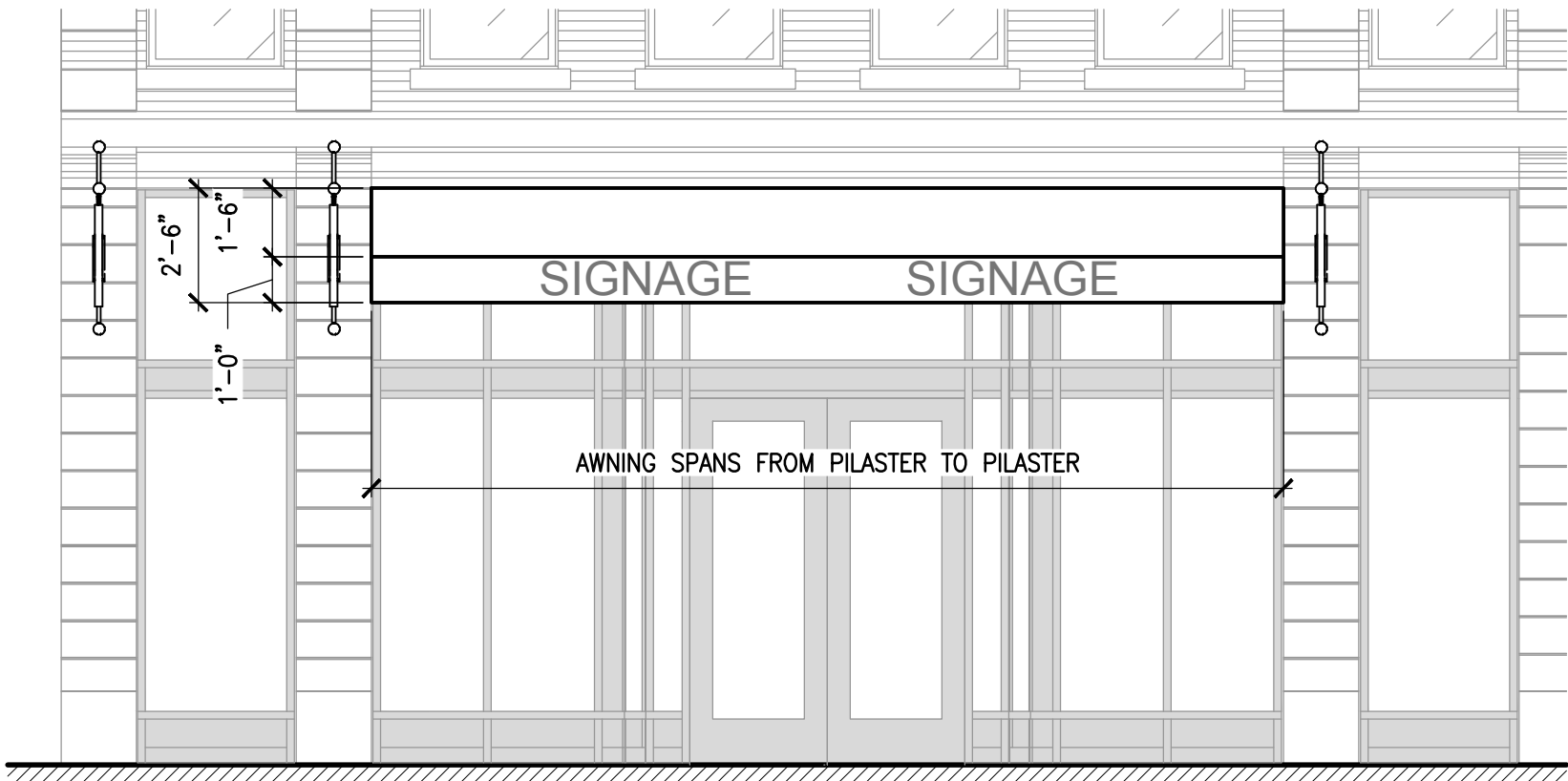

ELEVATION - OPTION 2

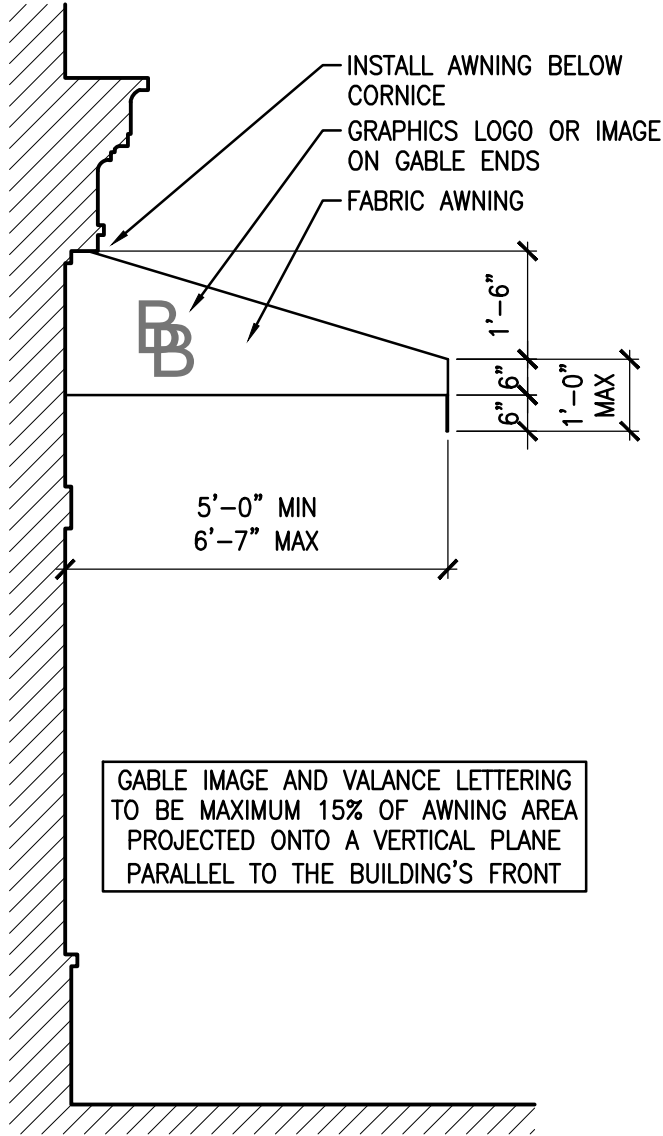

RETRACTABLE AWNING SIDE ELEVATION

# PROJECTING SIGNAGE

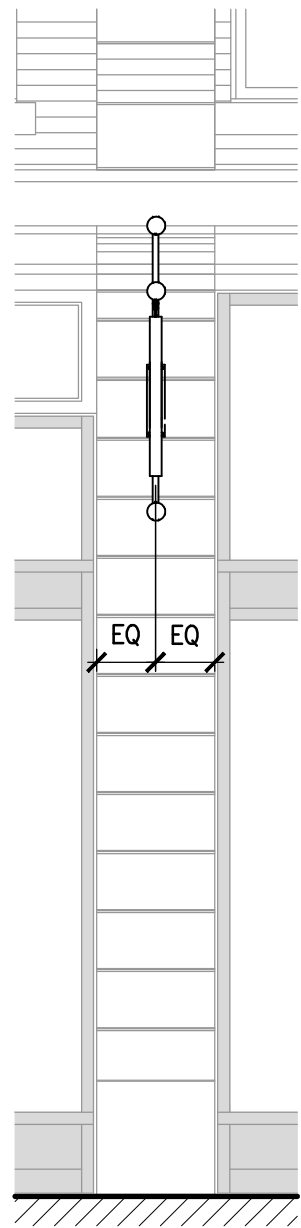

ELEVATION

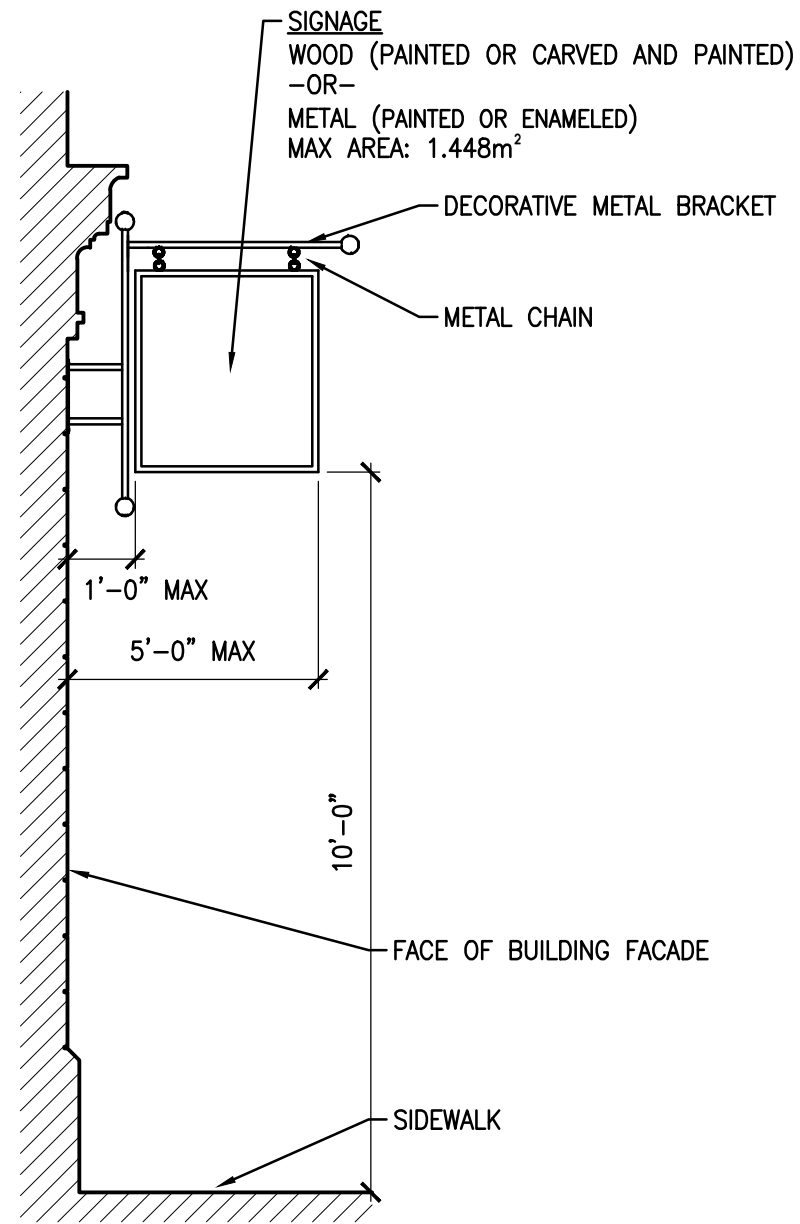

SIDE ELEVATION

# WINDOW SIGNAGE

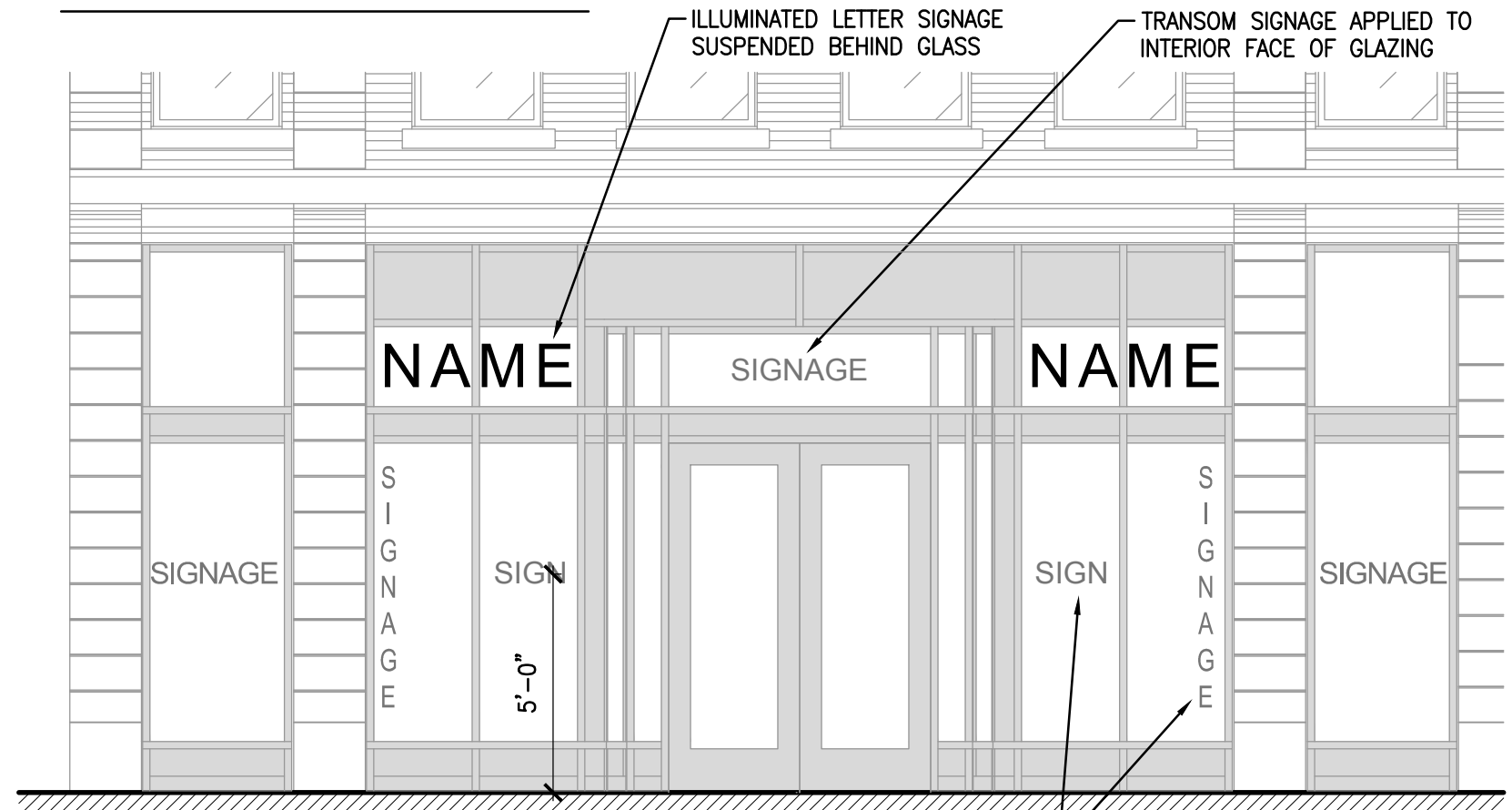

SIGNAGE APPLIED TO INTERIOR FACE OF GLAZING VERTICALLY OR HORIZONTALLY. SIGNAGE TO FIT WITHIN A RECTANGLE OCCUPYING MAX 30% OF TOTAL WINDOW AREA.

ELEVATION

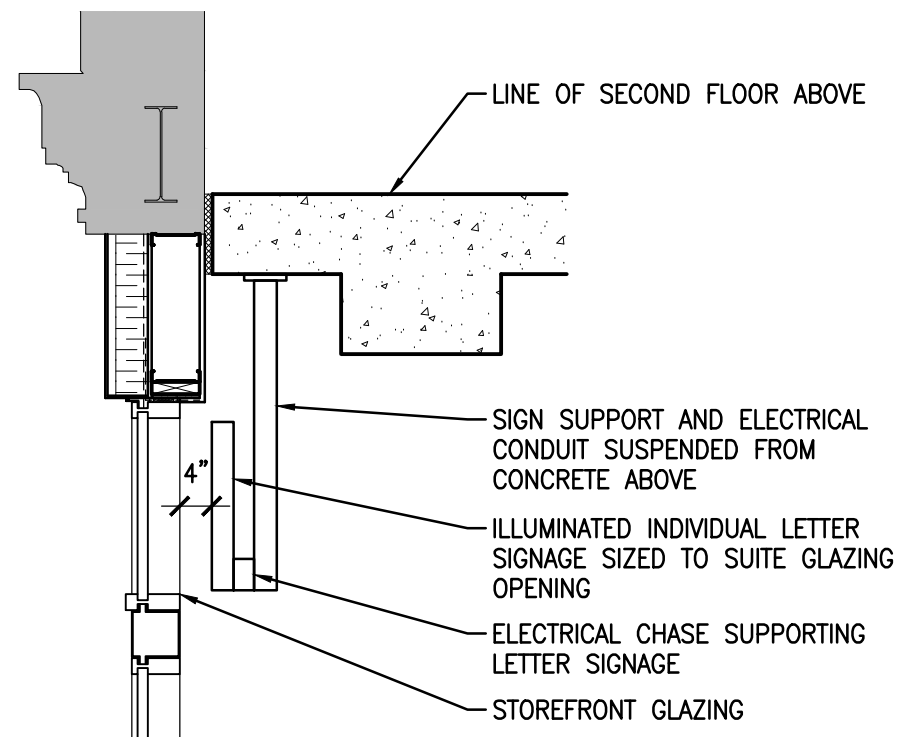

LETTER SIGNAGE SECTION

WINDOW SIGNAGE TO BE LIMITED TO TENANT NAME/TYPE OF BUSINESS ONLY. ILLUMINATED SIGNAGE TO BE NON-FLASHING. FLUORESCENT OR COLOURED LIGHTING NOT TO BE USED.